

Valvole a singola sede
Single seat valves



B BZP

BBZP



BBZP
Deviatrice / Divert



CERTIFICAZIONI
CERTIFICATIONS



DATI TECNICI

STRUTTURA VALVOLA		
Connessioni da DN10 a DN150	DIN, SMS, IDF, BS (RJT), Clamp, Flangia	Altre connessioni a richiesta
Materiale a contatto con il prodotto	AISI 316L (1.4404)	Altro materiale a richiesta
Materiale guarnizioni a contatto con il prodotto (omologazione FDA)	EPDM, FKM, HNBR e PTFE	Altro materiale a richiesta
Temperatura massima prodotto (EPDM applicazioni con aria)	150 °C (302 °F)	Per temperature diverse, contattare Bardiani Valvole
Temperatura minima prodotto (EPDM applicazioni con aria)	-10 °C (14 °F)	
Pressione massima prodotto	10 bar (145 psi)	
Pressione massima di tenuta	Vedi tabella	
Finitura superficiale materiale a contatto con il prodotto	Ra 0,8 µm (altri tipi di finitura a richiesta)	
STRUTTURA ATTUATORE PNEUMATICO		
Attacchi aria	1/8" (BSP) per tubo 6 x 4 mm	
Pressione	Da 6 bar (87 psi) a 8 bar (116 psi)	
Materiale cilindro	AISI 304 (1.4301)	
Materiale guarnizioni	NBR	

TECHNICAL DETAILS

VALVE STRUCTURE		
Connections from DN10 to DN150	DIN, SMS, IDF, BS (RJT), Clamp, Flange	Other connections on request
Material in contact with the product	AISI 316L (1.4404)	Other material on request
Material gaskets in contact with the product (FDA homologation)	EPDM, FKM, HNBR and PTFE	Other material on request
Max product temperature (EPDM applications with air)	150 °C (302 °F)	For other temperature, please ask Bardiani Valvole
Min product temperature (EPDM applications with air)	-10 °C (14 °F)	
Max product pressure	10 bar (145 psi)	
Max working pressure	See table	
Finish on surfaces in contact with the product	Ra 0.8 µm (other types of surface finish on request).	
PNEUMATIC ACTUATOR STRUCTURE		
Air connectors	1/8" (BSP) for pipe 6 x 4 mm	
Air pressure	From 6 bar (87 psi) to 8 bar (116 psi)	
Cylinder material	AISI 304 (1.4301)	
Gasket material	NBR	

BBZM

VALVOLA AD AZIONAMENTO
MANUALE CON/SENZA LEVA



BBZM

MANUAL OPERATED VALVE
WITH/OUT HANDLE

LIMITATORE DI CORSA

Accessorio che consente
la regolazione meccanica della corsa



STROKE LIMITER

Device that allows the mechanical regulation
of the valve stroke

CILINDRO MAGGIORATO

La versatilità della valvole a singola sede permette
di adattare i vari cilindri pneumatici in funzione
delle pressioni di lavoro.

Per maggiori informazioni sulle pressioni di
tenuta, contattare la Bardiani Valvole



OVERSIZED ACTUATOR

It is very easy to switch over-sized actuators for
different working pressure. For further information
please contact Bardiani Valvole.

ESECUZIONI SPECIALI SU RICHIESTA

Ogni accessorio è disponibile su richiesta del cliente per tutti
i diametri e tutte le configurazioni corpi valvola. È inoltre
possibile la personalizzazione di attacchi, diametri oppure
soluzioni non presenti a catalogo. Bardiani Valvole consiglia
di consultare sempre l'ufficio tecnico in fase d'ordine per
ulteriori informazioni e studi di fattibilità.

SPECIAL OPTIONS AND VARIATION ON REQUEST

On request all accessories are available for all sizes of
valve and body configurations. Additionally special ports,
diameters and other tailor-made solutions are available.
Bardiani Valvole can also provide technical support, advice
and feasibility analysis for other requests.

CONFIGURAZIONI **CORPI ORIENTABILI** VALVOLE ON-OFF ON-OFF VALVES **ORIENTABLE BODY** CONFIGURATIONS

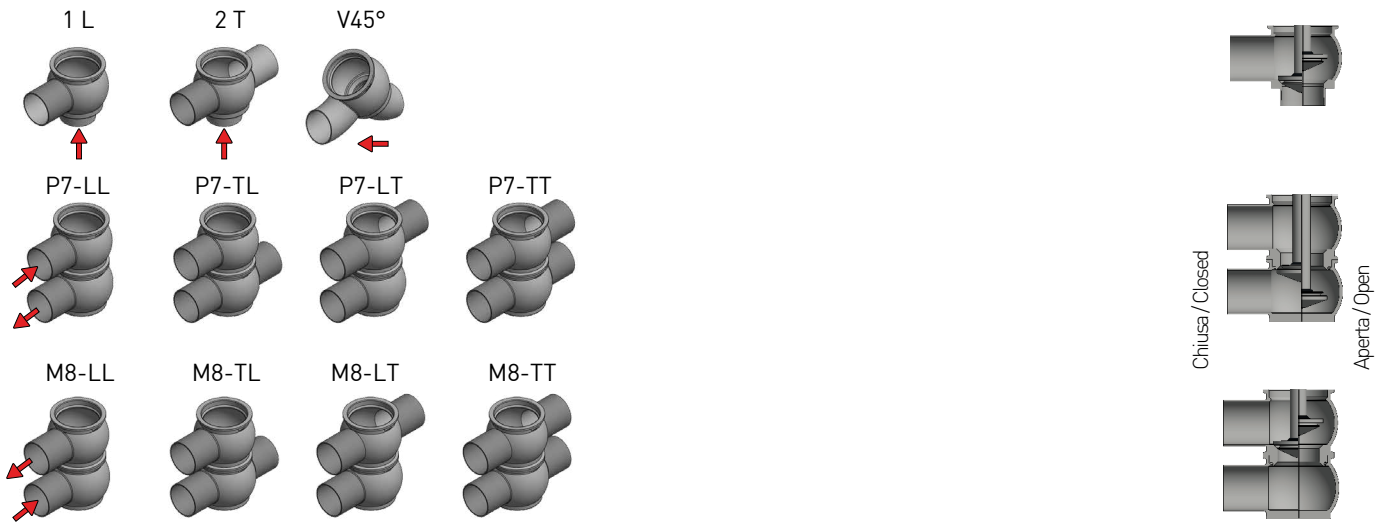

CONFIGURAZIONI **DOPPIO CORPO UNICO** VALVOLE ON-OFF ON-OFF VALVES **SOLID DOUBLE BODY** CONFIGURATIONS

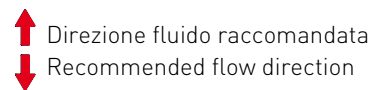
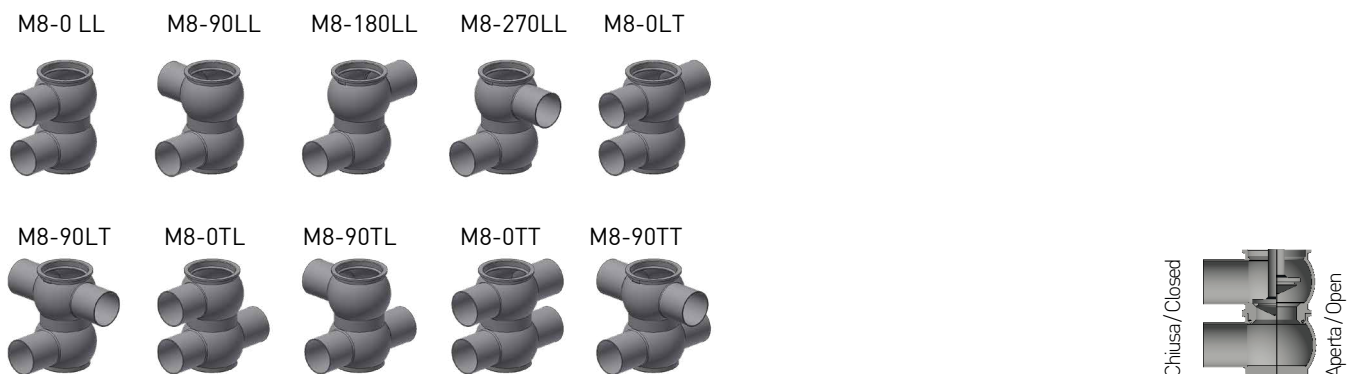

VANTAGGI DEL DOPPIO CORPO UNICO

- Riduzione dei tempi di manutenzione (ridotto numero di guarnizioni)
- Migliore pulizia della valvola (minori punti di contaminazione).
- Ideale per inserimento in gruppi valvole

ADVANTAGE OF SOLID DOUBLE BODY

- Easy maintenance: reduced service time and less gaskets
- Maximum hygiene and cleanability (less contamination points)
- Ideal for valve clusters

ESEMPI DI LETTURA PER ATTACCHI EXAMPLES OF HOW TO READ END CONNECTIONS

1°- 2°- 3°... esempi di lettura per attacchi con tipi e/o dimensioni diverse

1st - 2nd - 3rd examples how to read end connections with different types and/or dimensions



SENSO ORARIO

CLOCK WISE

CONFIGURAZIONI **CORPI ORIENTABILI** VALVOLE DEVIATRICI DIVERT VALVES **ORIENTABLE BODY** CONFIGURATIONS

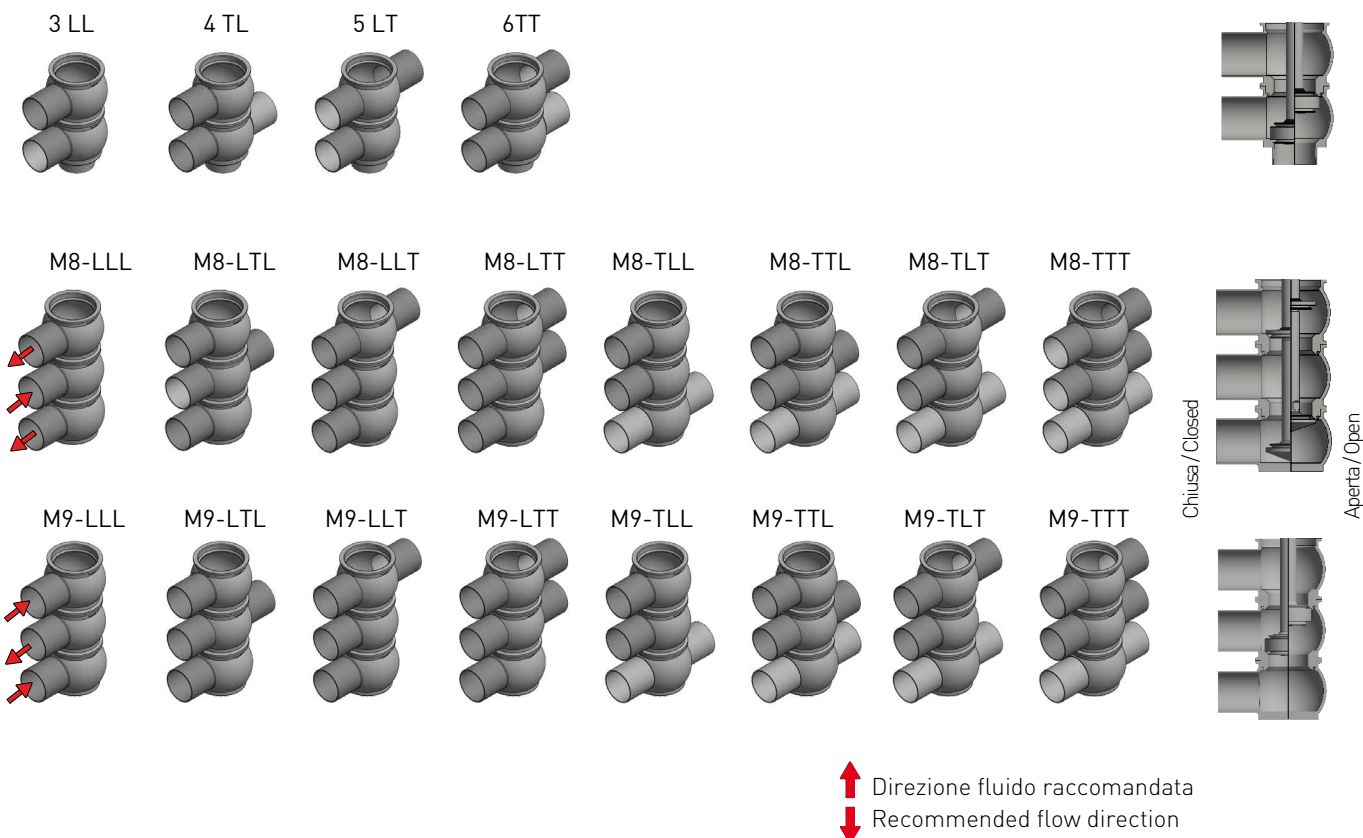

Direzione fluido raccomandata
 Recommended flow direction

ESEMPI DI LETTURA PER ATTACCHI EXAMPLES OF HOW TO READ END CONNECTIONS

1°- 2°- 3°... esempi di lettura per attacchi con tipi e/o dimensioni diverse
1st - 2nd - 3rd examples of how to read end connections with different types and/or dimensions

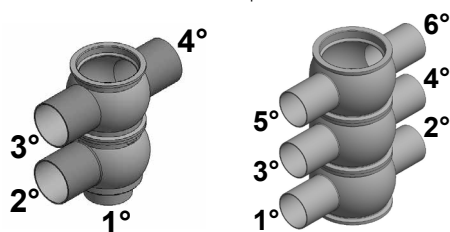

ESEMPI DI CONFIGURAZIONI ATTACCHI MISTI EXAMPLES OF DIFFERENT END CONNECTION CONFIGURATIONS

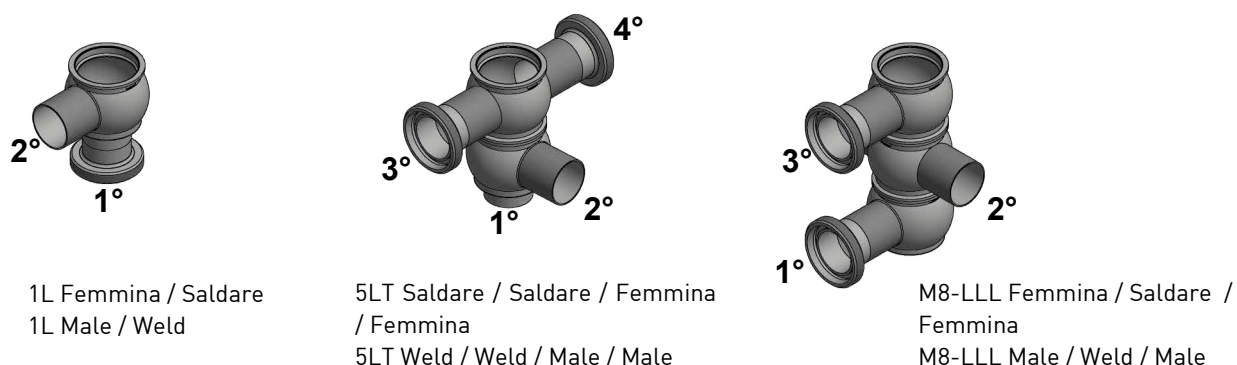

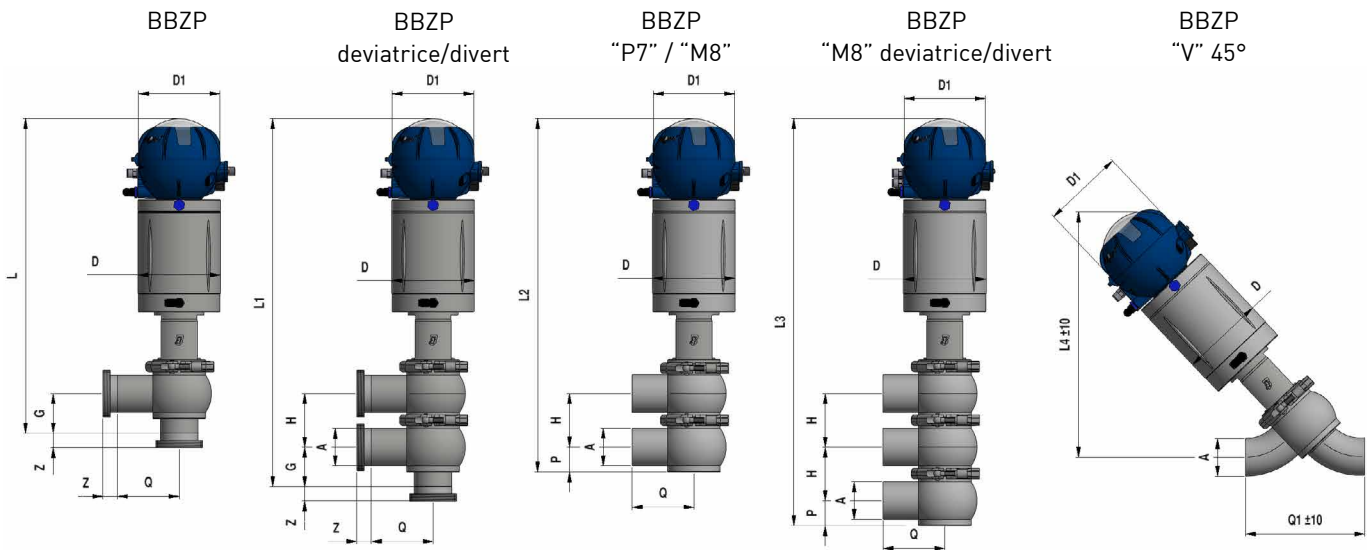

DN	S/S DIN 11850-2											F/F DIN	M/G DIN	S/S (altre dimensioni / other dimension)		
	A	D	D1	G	H	L	L1	L2	L3	L4	P	Q	Q1	Z	Z	A
10	13x1.5	64	112	30	50	341	391	376	426	263	15	45	72	21	17	
15	19x1.5	64	112	33	50	341	391	376	426	264	18	45	86	21	17	
20	23x1.5	64	112	35	50	341	391	376	426	262	20	50	84	24	18	
25	29x1.5	64	112	43	50	346	396	376	426	265	23	65	107	29	22	28x1.5
32	35x1.5	90	112	46	62	370	432	412	474	281	26	70	99	32	25	34x1.5
40	41x1.5	90	112	49	62	370	432	412	474	285	29	70	128	33	26	40x1.5
50	53x1.5	115	112	55	74	432	506	486	560	331	35	85	151	35	28	52x1.5
65	70x2	115	112	63	90	448	538	518	608	346	43	95	177	40	32	
80	85x2	140	145	70.5	105	512	617	597	702	398	51	105	206	45	37	
100	104x2	140	145	80	124	531	655	635	759	422	59	120	274	54	44	
125	129x2	219	145	102.5	161	678	840	810	970	-	72.5	140	-	46	34	
150	154x2	219	145	115	186	703	890	860	1045	-	85	155	-	50	37	

DN	S/S INCHES											F/F SMS	F/F IDF	F/F BS		
	A	D	D1	G	H	L	L1	L2	L3	L4	P	Q	Q1	Z	Z	Z
1"	25.4x1.5	64	112	41.5	50	346	396	376	426	263	22	65	91	15	21.5	26.5
1" 1/2	38.1x1.5	90	112	47.5	62	370	432	412	474	285	28	70	125	20	21.5	26.5
2"	50.8x1.5	115	112	54	74	432	506	502	560	334	34	85	158	20	21.5	26.5
2" 1/2	63.5x1.5	115	112	60.5	90	467	538	518	608	352	41	95	198	24	21.5	26.5
3"	76.1x2	140	145	66	105	512	617	597	702	408	46	105	236	24	21.5	26.5
4"	101.6x2	140	145	79	124	531	655	635	759	422	59	120	274	25	21.5	26.5

DN	S/S ASME-BPE											CLAMP		
	A	D	D1	G	H	L	L1	L2	L3	L4	P	Q	Q1	Z
1/2"	12.7x1.65	64	112	30	50	341	391	376	426	-	15	45	-	12.7
3/4"	19.05x1.65	64	112	33	50	341	391	376	426	-	18	45	-	12.7
1"	25.4x1.65	64	112	41.5	50	346	396	376	426	263	22	65	91	12.7
1" 1/2	38.1x1.65	90	112	47.5	62	370	432	412	474	285	28	70	125	12.7
2"	50.8x1.65	115	112	54	74	432	506	502	560	334	34	85	158	12.7
2" 1/2	63.5x1.65	115	112	60	90	467	538	518	608	352	41	95	198	12.7
3"	76.2x1.65	140	145	66.5	105	512	617	597	702	408	46	105	236	12.7
4"	101.6x2.11	140	145	79	124	531	655	635	759	422	59	120	274	15.8
6"	152.4x2.77	219	145	113.5	186	733	890	-	-	-	-	155	-	28.6

Altre dimensioni su richiesta / Other dimensions on request

LEGENDA / KEY	
S/S DIN	Saldare / Welding
F/F DIN	Femmina / Male
M/G DIN	Maschio + girella / Liner + nut
S/S DIN 11850/2	Saldare / Welding Din 11850/2
CLAMP	Clamp
F/F SMS	Femmina / Male SMS
F/F IDF	Femmina / Male IDF
F/F BS	Femmina / Male BS
-	Su richiesta / On demand

S.E.N.C. / S.A.N.C.				
DIN / DN	INCHES / DN	cil./ cyl.	P1 bar / psi	P2 bar / psi
10-15-20-25	1/2" - 3/4" - 1"	59	8/116	10/145
32-40	1 1/2"	83	9/130	10/145
50	2"	108	9/130	10/145
65	2 1/2"	108	5/72	6/87
80	3"	134	6/87	6/87
100	4"	134	4/58	4.5/65
125		207	6/87	3.1/44
150	6"	207	4.8/69	2.5/36

S.E.N.A. / S.A.N.O.				
DIN / DN	INCHES / DN	cil./ cyl.	P1 bar / psi	P2 bar / psi
10-15-20-25	1/2" - 3/4" - 1"	59	9/130	10/145
32-40	1 1/2"	83	9/130	10/145
50	2"	108	9/130	10/145
65	2 1/2"	108	4.5/65	6.5/94
80	3"	134	4.5/65	8/116
100	4"	134	3.2/46	5/72
125		207	-	-
150	6"	207	-	-

D.E. / D.A.				
DIN / DN	INCHES / DN	cil./ cyl.	P1 bar / psi	P2 bar / psi
10-15-20-25	1/2" - 3/4" - 1"	59	10/145	10/145
32-40	1 1/2"	83	10/145	10/145
50	2"	108	10/145	10/145
65	2 1/2"	108	10/145	10/145
80	3"	134	10/145	10/145
100	4"	134	9/130	9/130
125		207	10/145	10/145
150	6"	207	10/145	10/145

S.E.N.C. / S.A.N.C.					
DIN / DN	INCHES / DN	cil./ cyl.	P1 bar / psi	P2 bar / psi	P3 bar / psi
10-15-20-25	1/2" - 3/4" - 1"	59	8/116	10/145	8/116
32-40	1 1/2"	83	9/130	10/145	10/145
50	2"	108	9/130	10/145	10/145
65	2 1/2"	108	5/72	4.7/68	6.5/94
80	3"	134	6/87	4.7/68	6.5/94
100	4"	134	4/58	3.3/48	4.7/68
125		207	-	-	-
150	6"	207	-	-	-

S.E.N.A. / S.A.N.O.					
DIN / DN	INCHES / DN	cil./ cyl.	P1 bar / psi	P2 bar / psi	P3 bar / psi
10-15-20-25	1/2" - 3/4" - 1"	59	9/130	10/145	9/130
32-40	1 1/2"	83	9/130	10/145	10/145
50	2"	108	9/130	10/145	10/145
65	2 1/2"	108	4.5/65	6/87	6/87
80	3"	134	4.5/65	6/87	6/87
100	4"	134	3.2/46	4.2/61	4/58
125		207	-	-	-
150	6"	207	-	-	-

D.E. / D.A.					
DIN / DN	INCHES / DN	cil./ cyl.	P1 bar / psi	P2 bar / psi	P3 bar / psi
10-15-20-25	1/2" - 3/4" - 1"	59	10/145	10/145	10/145
32-40	1 1/2"	83	10/145	10/145	10/145
50	2"	108	10/145	10/145	10/145
65	2 1/2"	108	10/145	10/145	10/145
80	3"	134	10/145	10/145	10/145
100	4"	134	9/130	9/130	9/130
125		207	-	-	-
150	6"	207	-	-	-

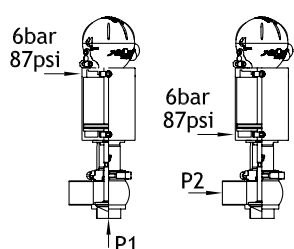
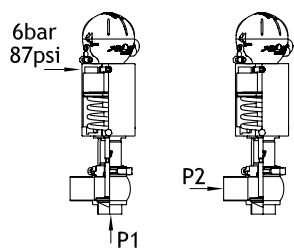
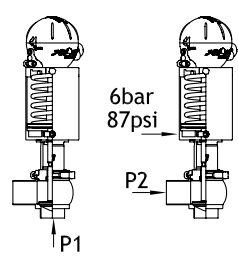

LEGENDA / KEY	
S.E.N.C. / S.A.N.C.	Valvola normalmente chiusa con attuatore a semplice effetto (molla chiude/aria apre) Valve normally closed with single acting actuator (air opens/spring closes)
S.E.N.A. / S.A.N.O.	Valvola normalmente aperta con attuatore a semplice effetto (aria chiude/molla apre) Valve normally opened with single acting actuator (air closes/spring opens)
D.E. / D.A.	Valvola con attuatore a doppio effetto (aria apre/aria chiude) Valve with double acting actuator (air opens/air closes)
cil./cyl	Cilindro / Cylinder
-	Su richiesta / On demand

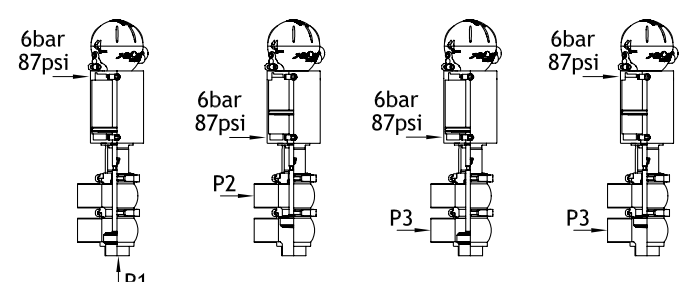
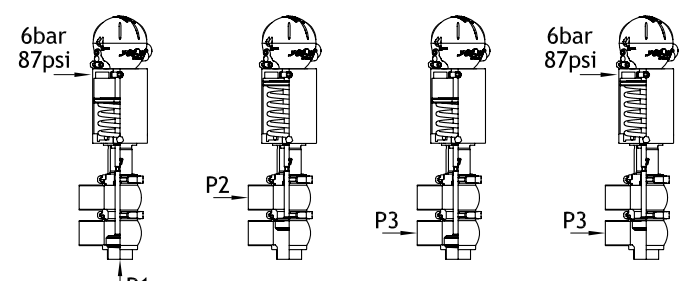
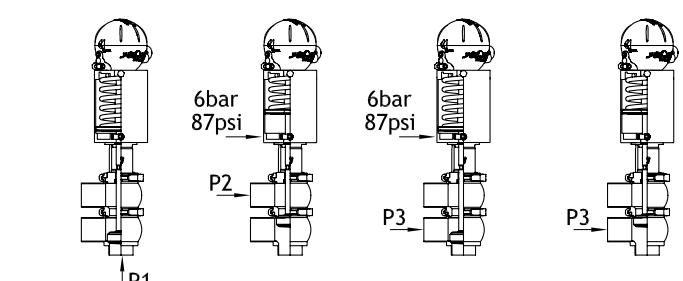

BBZP			
DN	S	S1	S2
10	9	8	3.5
15	11	8	6
20	11	8.5	7
25	11	8.5	7
40 - 1" 1/2	19	16.5	9.5
50 - 2"	33	31	14
65 - 2" 1/2	33	31	23
80 - 3"	33	31	30
100 - 4"	34	31	30
125	43	40	40
150	43	40	40

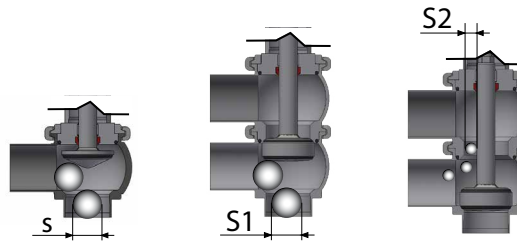

Consumi Aria - Air consumption				
Litri per pressione aria/ciclo - Litre for air pressure/cycle				
DIN / DN	INCHES / DN	cil. / cyl.	SE NC	DE
10-15-20-25	1/2" - 3/4" - 1"	59	0.05	0.18
32-40	1" 1/2	83	0.19	0.56
50	2"	108	0.19	0.56
65	2" 1/2	108	0.48	1.43
80	3"	134	0.48	1.43
100	4"	134	0.71	2.76
125		207	0.71	2.76
150	6"	207	0.98	4.02

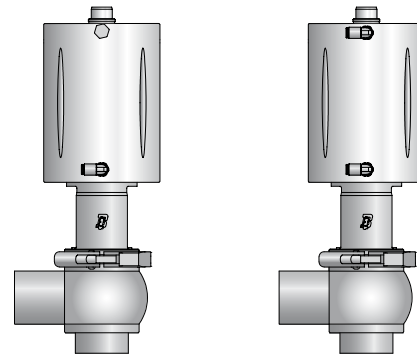

PRESSIONI MASSIME DI TENUTA (BAR/PSI) MAXIMUM SEAL PRESSURES (BAR/PSI)

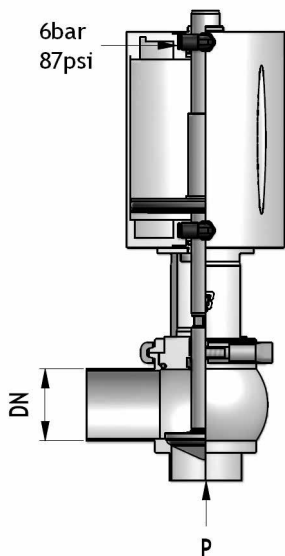

P bar / psi					
DIN DN	INCHES DN	CILINDRO D.E. / CYLINDER D.A.			
		59	83	108	134
10-15-20-25	1"	10 / 145			
32 - 40	1" 1/2	9 / 130	10 / 145		
50	2"	5.5 / 80	10 / 145		
65	2" 1/2	3.2 / 46	6.6 / 96	10 / 145	
80	3"	2.2 / 32	4.5 / 65	7.7 / 112	10 / 145
100	4"		3.2 / 46	5.5 / 80	9 / 125

LEGENDA / KEY	
DN	Diametro nominale / Nominal diameter
D.E. / D.A.	Valvola con attuatore a doppio effetto (aria apre/aria chiude) Valve with double acting actuator (air opens/air closes)

OTTURATORE PARABOLICO

L'utilizzo di un'otturatore con profilo parabolico consente di ottenere una chiusura più dolce della valvola.

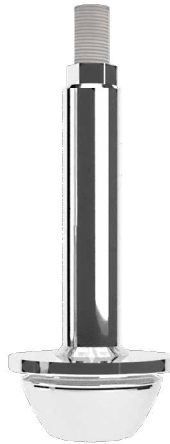

PARABOLIC SHUTTER

The parabolic profile of the shutter allows a better closing operation.

REGOLATORE DI PRESSIONE + MANOMETRO

L'utilizzo di un regolatore di pressione è particolarmente consigliato per le valvole by-pass pneumatiche. Tramite questo accessorio è possibile infatti ottenere la regolazione della pressione dell'aria entrante nella parte pneumatica della valvola, modificando di fatto la pressione di tenuta. Impiegato unitamente al regolatore di pressione, il manometro permette di visualizzare la pressione di alimentazione aria della valvola.



PRESSURE REGULATOR + MANOMETER

The pressure regulator is a good solution for pneumatic by-pass valve. With this device, it is possible to regulate the air pressure into the pneumatic actuator, modifying the seal pressure. Fitted with the pressure regulator, the manometer shows the air supplying.

BBZR



DATI TECNICI

STRUTTURA VALVOLA		
Conessioni da DN65 a DN150	DIN, SMS, IDF, BS (RJT), Clamp, Flangia	Altre connessioni a richiesta
Materiale a contatto con il prodotto	AISI 316L (1.4404)	Altro materiale a richiesta
Materiale guarnizioni a contatto con il prodotto (omologazione FDA)	EPDM, FKM, HNBR e PTFE	Altro materiale a richiesta
Temperatura massima prodotto (EPDM)	150 °C (302 °F)	Per temperature diverse, contattare Bardiani Valvole
Temperatura minima prodotto (EPDM)	-10 °C (14 °F)	
Pressione massima prodotto	10 bar (145 psi)	
Pressione massima di tenuta	Vedi tabella	
Finitura superficiale materiale a contatto con il prodotto	Ra 0,8 µm (altri tipi di finitura a richiesta)	
STRUTTURA ATTUATORE PNEUMATICO		
Attacchi aria	1/8" (BSP) per tubo 6 x 4 mm	
Pressione	Da 6 bar (87 psi) a 8 bar (116 psi)	
Materiale cilindro	AISI 304 (1.4301)	
Materiale guarnizioni	NBR	

BBZR
Deviatrice / Divert



TECHNICAL DETAILS

VALVE STRUCTURE		
Connections from DN65 to DN150	DIN, SMS, IDF, BS (RJT), Clamp, Flange	Other connections on request
Material in contact with the product	AISI 316L (1.4404)	Other material on request
Material gaskets in contact with the product (FDA homologation)	EPDM, FKM, HNBR and PTFE	Other material on request
Max. product temperature (EPDM)	150 °C (302 °F)	For other temperature, please ask Bardiani Valvole
Min. product temperature (EPDM)	-10 °C (14 °F)	
Max product pressure	10 bar (145 psi)	
Max working pressure	See table	
Finish on surfaces in contact with the product	Ra 0.8 µm (other types of surface finish on request)	
PNEUMATIC ACTUATOR STRUCTURE		
Air connectors	1/8" (BSP) for pipe 6 x 4 mm	
Air pressure	From 6 bar (87 psi) to 8 bar (116 psi)	
Cylinder material	AISI 304 (1.4301)	
Gasket material	NBR	

CERTIFICAZIONI
CERTIFICATIONS



BBZMR

VALVOLA AD AZIONAMENTO
MANUALE CON/SENZA LEVA



BBZMR

MANUAL OPERATED VALVE
WITH/WITHOUT HANDLE



BBYR

BARRIERA VAPORE

Impiegata in applicazioni particolarmente delicate dove sterilità, asetticità o alte temperature di sterilizzazione sono necessarie. L'utilizzo di una barriera di vapore posta tra il corpo valvola e la parte pneumatica consente di ottenere una sicura separazione fra prodotto all'interno della valvola ed ambiente esterno.

BBYR

STEAM BARRIER

A steam barrier is recommended for very hygiene applications such as sterile, aseptic processing or high temperature sterilization. The steam barrier, placed between the valve body and the pneumatic actuator, minimises the risk of the product coming into contact with the external atmosphere.

CILINDRO MAGGIORATO

La versatilità della valvole a singola sede permette di adattare i vari cilindri pneumatici in funzione delle pressioni di lavoro.

Per maggiori informazioni sulle pressioni di tenuta, contattare la Bardiani Valvole

OVERSIZED ACTUATOR

It is very easy to switch over-sized actuators for different working pressure. For further information please contact Bardiani Valvole.



ESECUZIONI SPECIALI SU RICHIESTA

Ogni accessorio è disponibile su richiesta del cliente per tutti i diametri e tutte le configurazioni corpi valvola. È inoltre possibile la personalizzazione di attacchi, diametri oppure soluzioni non presenti a catalogo. Bardiani Valvole consiglia di consultare sempre l'ufficio tecnico in fase d'ordine per ulteriori informazioni e studi di fattibilità.

SPECIAL OPTIONS AND VARIATION ON REQUEST

On request all accessories are available for all sizes of valve and body configurations. Additionally special ports, diameters and other tailor-made solutions are available. Bardiani Valvole can also provide technical support, advice and feasibility analysis for other requests.

CONFIGURAZIONI CORPI VALVOLE ON-OFF VALVES BODY CONFIGURATIONS

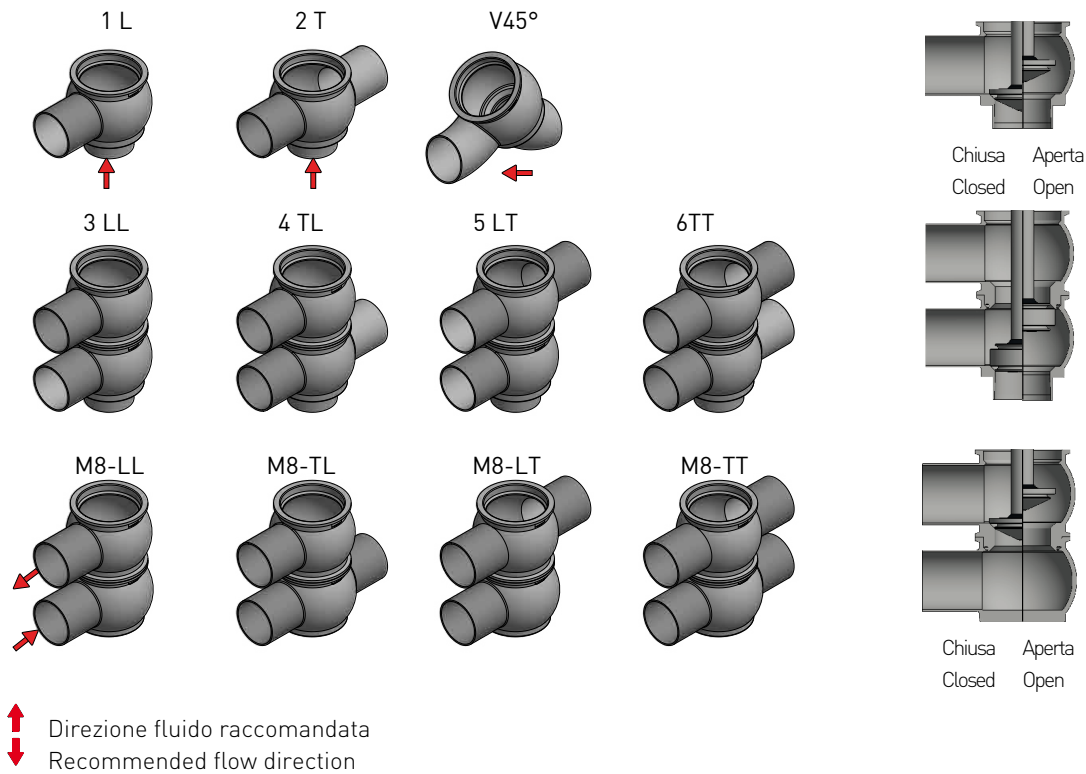

ESEMPI DI LETTURA PER ATTACCHI EXAMPLES OF HOW TO READ END CONNECTIONS

1° - 2° - 3°... esempi di lettura per attacchi con tipi e/o dimensioni diverse
1st - 2nd - 3rd examples of how to read end connections with different types and/or dimensions



ESEMPI DI CONFIGURAZIONI ATTACCHI MISTI EXAMPLES OF DIFFERENT END CONNECTION CONFIGURATIONS

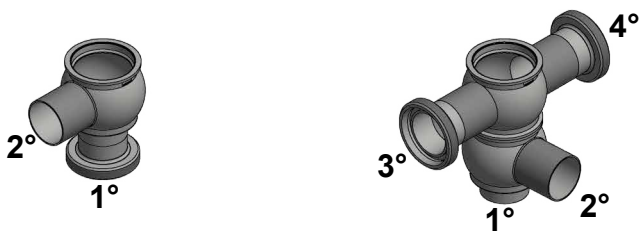

1L Femmina / Saldare
1L Male / Weld

5LT Saldare / Saldare / Femmina / Femmina
5LT Weld / Weld / Male / Male

DN	S/S DIN 11850-2								F/F DIN	M/G DIN
	A	D	D1	G	H	L	L1	Q	Z	Z
65	70x2	115	145	63	90	492	582	95	40	32
80	85x2	140	145	70.5	105	606	711	105	45	37
100	104x2	140	145	80	124	625	749	120	54	44

DN	S/S INCHES								F/F SMS	F/F IDF	F/F BS
	A	D	D1	G	H	L	L1	Q	Z	Z	Z
2" 1/2	63.5x1.5	115	145	60.5	90	492	582	95	24	21.5	26.5
3"	76.1x2	140	145	66	105	606	711	105	24	21.5	26.5
4"	101.6x2	140	145	79	124	625	749	120	25	21.5	26.5

DN	S/S ASME-BPE								CLAMP
	A	D	D1	G	H	L	L1	Q	Z
2" 1/2	63.5x1.65	115	145	60	90	492	582	95	12.7
3"	76.2x1.65	140	145	66.5	105	606	711	105	12.7
4"	101.6x2.11	140	145	79	124	625	749	120	15.8

Altre dimensioni su richiesta / Other dimensions on request



BBZR
deviatrice/divert



BBZR con guarnizioni EPDM, FKM, HNBR			
BBZR with seals EPDM, FKM, HNBR			
DN	S	S1	S2
65 - 2" 1/2	47	43	23
80 - 3"	60	59	30
100 - 4"	79	78	38

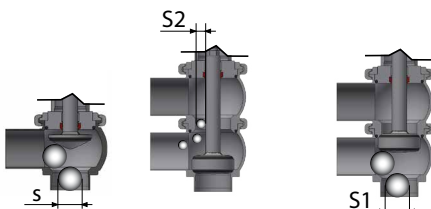

LEGENDA / KEY	
S/S DIN	Saldare / Welding
F/F DIN	Femmina / Male
M/G DIN	Maschio + girella / Liner + nut
S/S DIN 11850/2	Saldare / Welding Din 11850/2
CLAMP	Clamp
F/F SMS	Femmina / Male SMS
F/F IDF	Femmina / Male IDF
F/F BS	Femmina / Male BS

S.E.N.C. / S.A.N.C.				
DIN / DN	INCHES / DN	cil./cyl.	P1 bar / psi	P2 bar / psi
65	2" 1/2	108	4.5/65	6.5/94
80	3"	134	5.5/80	6.6/95
100	4"	134	3/43	6.3/91
125		207	-	-
150	6"	207	-	-

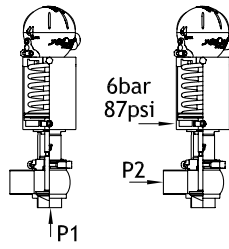

LEGENDA / KEY	
S.E.N.C. / S.A.N.C.	Valvola normalmente chiusa con attuatore a semplice effetto (molla chiude/aria apre) Valve normally closed with single acting actuator (air opens/spring closes)
S.E.N.A. / S.A.N.O.	Valvola normalmente aperta con attuatore a semplice effetto (aria chiude/molla apre) Valve normally opened with single acting actuator (air closes/spring opens)
D.E. / D.A.	Valvola con attuatore a doppio effetto (aria apre/aria chiude) Valve with double acting actuator (air opens/air closes)
cil./cyl.	Cilindro / Cylinder
-	Su richiesta / On demand

S.E.N.A. / S.A.N.O.				
DIN / DN	INCHES / DN	cil./cyl.	P1 bar / psi	P2 bar / psi
65	2" 1/2	108	3/43	9/130
80	3"	134	3.2/46	8/116
100	4"	134	1.4/20	5/72.5
125		207	-	-
150	6"	207	-	-

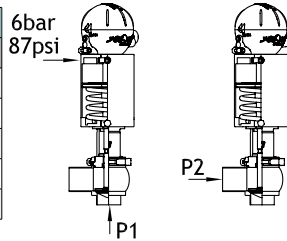

D.E. / D.A.				
DIN / DN	INCHES / DN	cil./cyl.	P1 bar / psi	P2 bar / psi
65	2" 1/2	108	10/145	10/145
80	3"	134	10/145	10/145
100	4"	134	9/130	9/130
125		207	-	-
150	6"	207	-	-

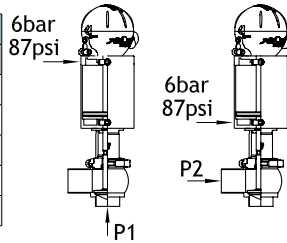

S.E.N.C. / S.A.N.C.					
DIN / DN	INCHES / DN	cil./cyl.	P1 bar / psi	P2 bar / psi	P3 bar / psi
65	2" 1/2	108	4.5/65	2.8/40	6.5/94
80	3"	134	5.5/80	2.3/33	6.6/95
100	4"	134	3/43	1.6/23	5/72
125		207	-	-	-
150	6"	207	-	-	-

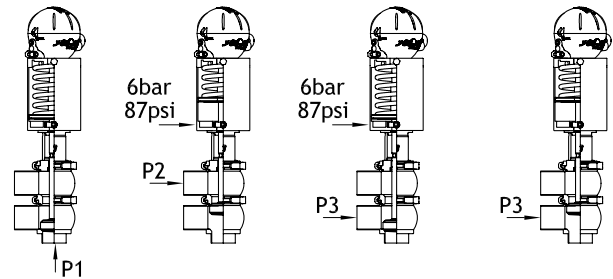

S.E.N.A. / S.A.N.O.					
DIN / DN	INCHES / DN	cil./cyl.	P1 bar / psi	P2 bar / psi	P3 bar / psi
65	2" 1/2	108	3/43	5.3/77	6/87
80	3"	134	3.2/46	4.5/65	7/101
100	4"	134	1.4/20	3/43	5/72
125		207	-	-	-
150	6"	207	-	-	-

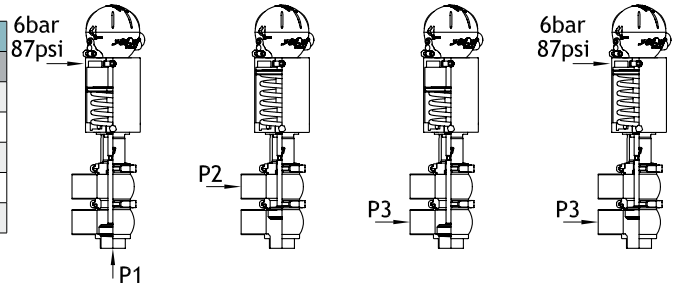

D.E. / D.A.					
DIN / DN	INCHES / DN	cil./cyl.	P1 bar / psi	P2 bar / psi	P3 bar / psi
65	2" 1/2	108	10/145	10/145	10/145
80	3"	134	10/145	10/145	10/145
100	4"	134	9/130	9/130	9/130
125		207	-	-	-
150	6"	207	-	-	-

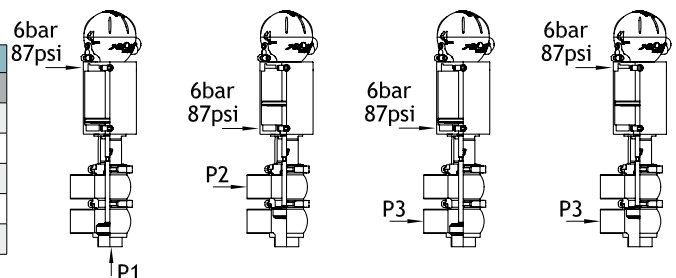

BBYP



BBYP
Deviatrice / Divert



CERTIFICAZIONI
CERTIFICATIONS



STRUTTURA VALVOLA		
Connessioni da DN10 a DN150	DIN, SMS, IDF, BS (RJT), Clamp, Flangia	Altre connessioni a richiesta
Materiale a contatto con il prodotto	AISI 316L (1.4404)	Altro materiale a richiesta
Materiale guarnizioni a contatto con il prodotto (omologazione FDA)	EPDM, FKM, HNBR e PTFE	Altro materiale a richiesta
Temperatura massima prodotto (EPDM)	140 °C (284 °F)	Per temperature diverse, contattare Bardiani Valvole
Temperatura minima prodotto (EPDM)	-10 °C (14 °F)	
Pressione massima prodotto	10 bar (145 psi)	
Pressione massima di tenuta	Vedi tabella	
Pressione minima di tenuta	0 bar (0 psi) si sconsiglia il vuoto nelle applicazioni asettiche	
Finitura superficiale materiale a contatto con il prodotto	Ra 0,8 µm (altri tipi di finitura a richiesta)	
BARRIERA VAPORE		
Connessione barriera vapore	attacchi 1/8" (BSP)	
Temperatura massima vapore	130° C	
Pressione massima altri prodotti	3 bar	
STRUTTURA ATTUATORE PNEUMATICO		
Attacchi aria	1/8" (BSP) per tubo 6 x 4 mm	
Pressione	Da 6 bar (87 psi) a 8 bar (116 psi)	
Materiale cilindro	AISI 304 (1.4301)	
Materiale guarnizioni	NBR	

VALVE STRUCTURE		
Connections from DN10 to DN150	DIN, SMS, IDF, BS (RJT), Clamp, Flange	Other connections on request
Material in contact with the product	AISI 316L (1.4404)	Other material on request
Material gaskets in contact with the product (FDA homologation)	EPDM, FKM, HNBR and PTFE	Other material on request
Max. product temperature (EPDM)	140 °C (284 °F)	For higher temperature, please ask Bardiani Valvole
Min. product temperature (EPDM)	-10 °C (14 °F)	
Max product pressure	10 bar (145 psi)	
Max working pressure	See table	
Min working pressure	0 bar (0 psi) vacuum is not recommended in aseptic applications	
Finish on surfaces in contact with the product	Ra 0.8 µm (other types of surface finish on request)	
PNEUMATIC ACTUATOR STRUCTURE		
Air connectors	1/8" (BSP) for pipe 6 x 4 mm	
Air pressure	From 6 bar (87 psi) to 8 bar (116 psi)	
Cylinder material	AISI 304 (1.4301)	
Gasket material	NBR	

BBYM

VALVOLA AD AZIONAMENTO MANUALE CON/SENZA LEVA



BBYM

MANUAL OPERATED VALVE WITH/WITHOUT HANDLE



BBYT

TWIN-STOP

L'utilizzo di un cilindro pneumatico ausiliario, facilmente installabile sulle valvole aseptiche, rappresenta la soluzione ideale per ovviare ad eventuali colpi d'ariete riscontrabili su qualsiasi applicazione impiantistica. La valvola, configurata in questo modo permette anche di assolvere le funzioni di regolazione di portata, pesatura e dosaggio.

BBYT

TWIN-STOP

An auxiliary Twin-Stop pneumatic cylinder controls the final closure or initial opening of a valve. On aseptic valves, it is the ideal solution for avoiding water hammer caused by the rapid shutting of a valve. A valve with this configuration can be also used for flow regulation, weighing and dosing.

CILINDRO MAGGIORATO

La versatilità della valvole a singola sede permette di adattare i vari cilindri pneumatici in funzione delle pressioni di lavoro.

Per maggiori informazioni sulle pressioni di tenuta, contattare la Bardiani Valvole

OVERSIZED ACTUATOR

It is very easy to switch over-sized actuators for different working pressure. For further information please contact Bardiani Valvole.



ESECUZIONI SPECIALI SU RICHIESTA

Ogni accessorio è disponibile su richiesta del cliente per tutti i diametri e tutte le configurazioni corpi valvola. È inoltre possibile la personalizzazione di attacchi, diametri oppure soluzioni non presenti a catalogo. Bardiani Valvole consiglia di consultare sempre l'ufficio tecnico in fase d'ordine per ulteriori informazioni e studi di fattibilità.

SPECIAL OPTIONS AND VARIATION ON REQUEST

On request all accessories are available for all sizes of valve and body configurations. Additionally special ports, diameters and other tailor-made solutions are available. Bardiani Valvole can also provide technical support, advice and feasibility analysis for other requests.

CONFIGURAZIONI CORPI VALVOLE ON-OFF VALVES BODY CONFIGURATIONS

1 L 	2 T 	V45° 						
3 LL 	4 TL 	5 LT 	6 TT 					
P7-LL 	P7-TL 	P7-LT 	P7-TT 					
M8-LL 	M8-TL 	M8-LT 	M8-TT 					
Direzione fluido raccomandata Recommended flow direction								
M8-LLL 	M8-LTL 	M8-LLT 	M8-LTT 	M8-TLL 	M8-TTL 	M8-TLT 	M8-TTT 	
M9-LLL 	M9-LTL 	M9-LLT 	M9-LTT 	M9-TLL 	M9-TTL 	M9-TLT 	M9-TTT 	

Chiusa Aperta
Closed Open

Chiusa Aperta
Closed Open

Chiusa Aperta
Closed Open

ESEMPI DI LETTURA PER ATTACCHI MISTI EXAMPLES OF HOW TO READ END CONNECTIONS

1°- 2°- 3°.... esempi di lettura per attacchi con tipi e/o dimensioni diverse
1st - 2nd - 3rd examples of how to read end connections with different types and/or dimensions

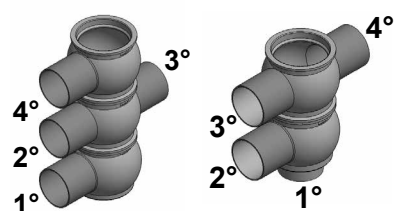

ESEMPI DI CONFIGURAZIONI ATTACCHI MISTI EXAMPLES OF DIFFERENT END CONNECTION CONFIGURATIONS

1L Femmina / Saldare 1L Male / Weld	5LT Saldare / Saldare / Femmina / Femmina 5LT Weld / Weld / Male / Male	M8-LLL Femmina / Saldare / Femmina M8-LLL Male / Weld / Male

DN	S/S DIN 11850-2								F/F DIN	M/G DIN	S/S (altre dimensioni / other dimension)
	A	D	D1	G	H	L	L1	Q	Z	Z	A
10	13x1.5	64	112	30	50	391	441	45	21	17	
15	19x1.5	64	112	33	50	391	441	45	21	17	
20	23x1.5	64	112	35	50	391	441	50	24	18	
25	29x1.5	64	112	43	50	396	446	65	29	22	28x1.5
32	35x1.5	90	112	46	62	420	482	70	32	25	34x1.5
40	41x1.5	90	112	49	62	420	482	70	33	26	40x1.5
50	53x1.5	115	112	55	74	482	556	85	35	28	52x1.5
65	70x2	115	112	63	90	498	588	95	40	32	
80	85x2	140	145	70.5	105	562	667	105	45	37	
100	104x2	140	145	80	124	581	705	120	54	44	
125	129x2	219	145	102.5	161	738	900	140	46	34	
150	154x2	219	145	115	186	763	950	155	50	37	

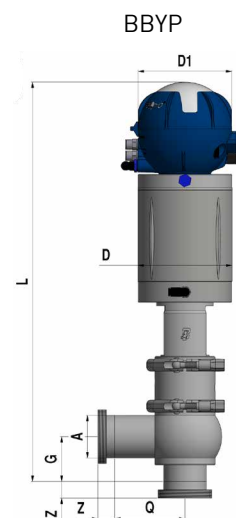

DN	S/S INCHES								F/F SMS	F/F IDF	F/F BS
	A	D	D1	G	H	L	L1	Q	Z	Z	Z
1"	25.4x1.5	64	112	41.5	50	396	446	65	15	21.5	26.5
1" 1/2	38.1x1.5	90	112	47.5	62	420	482	70	20	21.5	26.5
2"	50.8x1.5	115	112	54	74	482	556	85	20	21.5	26.5
2" 1/2	63.5x1.5	115	112	60.5	90	498	588	95	24	21.5	26.5
3"	76.1x2	140	145	66	105	562	667	105	24	21.5	26.5
4"	101.6x2	140	145	79	124	581	705	120	25	21.5	26.5

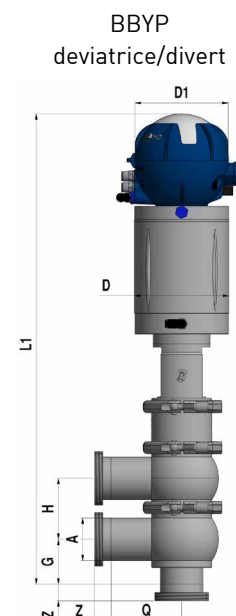

DN	S/S ASME-BPE								CLAMP
	A	D	D1	G	H	L	L1	Q	Z
1/2"	12.7x1.65	64	112	30	50	391	441	45	12.7
3/4"	19.05x1.65	64	112	33	50	391	441	45	12.7
1"	25.4x1.65	64	112	41.5	50	396	446	65	12.7
1" 1/2	38.1x1.65	90	112	47.5	62	420	482	70	12.7
2"	50.8x1.65	115	112	54	74	482	556	85	12.7
2" 1/2	63.5x1.65	115	112	60	90	498	588	95	12.7
3"	76.2x1.65	140	145	66.5	105	562	667	105	12.7
4"	101.6x2.11	140	145	79	124	581	705	120	15.8
6"	152.4x2.77	-	-	-	-	-	-	-	-

Altre dimensioni su richiesta / Other dimensions on request

LEGENDA / KEY	
S/S DIN	Saldare / Welding
F/F DIN	Femmina / Male
M/G DIN	Maschio + girella / Liner + nut
S/S DIN 11850/2	Saldare / Welding Din 11850/2
CLAMP	Clamp
F/F SMS	Femmina / Male SMS
F/F IDF	Femmina / Male IDF
F/F BS	Femmina / Male BS

S.E. N.C. / S.A. N.C.				
DIN / DN	INCHES / DN	cil./ cyl.	P1 bar / psi	P2 bar / psi
10-15-20-25	1/2" - 3/4" - 1"	59	9/130	10/145
32-40	1 1/2"	83	9/130	10/145
50	2"	108	9/130	10/145
65	2 1/2"	108	5/72	6/87
80	3"	134	6/87	6/87
100	4"	134	4/58	4.5/65
125		207	6/87	3.1/44
150	6"	207	4.8/69	2.5/36

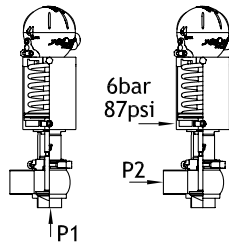

LEGENDA / KEY	
S.E.N.C. / S.A.N.C.	Valvola normalmente chiusa con attuatore a semplice effetto (molla chiude/aria apre) Valve normally closed with single acting actuator (air opens/spring closes)
S.E.N.A. / S.A.N.O.	Valvola normalmente aperta con attuatore a semplice effetto (aria chiude/molla apre) Valve normally opened with single acting actuator (air closes/spring opens)
D.E. / D.A.	Valvola con attuatore a doppio effetto (aria apre/aria chiude) Valve with double acting actuator (air opens/air closes)
cil./cyl	Cilindro / Cylinder
-	Su richiesta / On demand

S.E. N.A. / S.A. N.O.				
DIN / DN	INCHES / DN	cil./ cyl.	P1 bar / psi	P2 bar / psi
10-15-20-25	1/2" - 3/4" - 1"	59	9/130	10/145
32-40	1 1/2"	83	9/130	10/145
50	2"	108	9/130	10/145
65	2 1/2"	108	4.5/65	6.5/94
80	3"	134	4.5/65	8/116
100	4"	134	3.2/46	5/72
125		207	-	-
150	6"	207	-	-

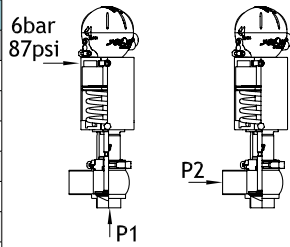

D.E. / D.A.				
DIN / DN	INCHES / DN	cil./ cyl.	P1 bar / psi	P2 bar / psi
10-15-20-25	1/2" - 3/4" - 1"	59	10/145	10/145
32-40	1 1/2"	83	10/145	10/145
50	2"	108	10/145	10/145
65	2 1/2"	108	10/145	10/145
80	3"	134	10/145	10/145
100	4"	134	9/130	9/130
125		207	10/145	10/145
150	6"	207	10/145	10/145

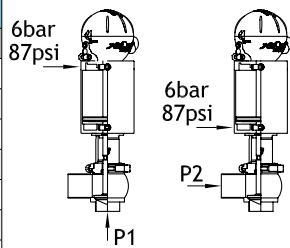

S.E. N.C. / S.A. N.C.					
DIN / DN	INCHES / DN	cil./ cyl.	P1 bar / psi	P2 bar / psi	P3 bar / psi
10-15-20-25	1/2" - 3/4" - 1"	59	9/130	10/145	8/116
32-40	1 1/2"	83	9/130	10/145	10/145
50	2"	108	9/130	10/145	10/145
65	2 1/2"	108	5/72	4.7/68	6.5/94
80	3"	134	6/87	4.7/68	6.5/94
100	4"	134	4/58	3.3/48	4.7/68
125		207	-	-	-
150	6"	207	-	-	-

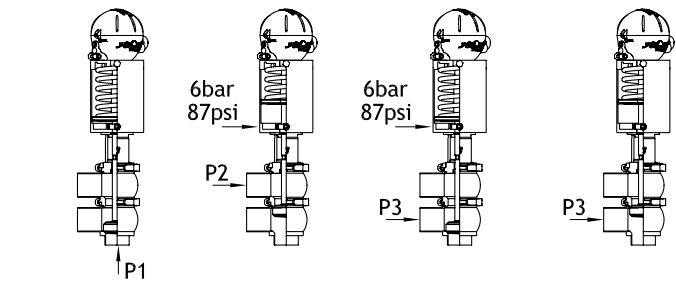

S.E. N.A. / S.A. N.O.					
DIN / DN	INCHES / DN	cil./ cyl.	P1 bar / psi	P2 bar / psi	P3 bar / psi
10-15-20-25	1/2" - 3/4" - 1"	59	9/130	10/145	9/130
32-40	1 1/2"	83	9/130	10/145	10/145
50	2"	108	9/130	10/145	10/145
65	2 1/2"	108	4.5/65	6/87	6/87
80	3"	134	4.5/65	6/87	6/87
100	4"	134	3.2/46	4.2/61	4/58
125		207	-	-	-
150	6"	207	-	-	-

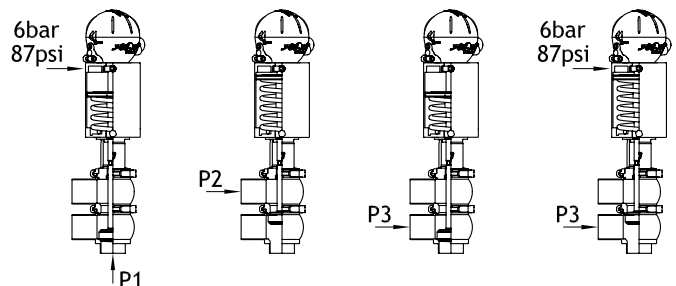

D.E. / D.A.					
DIN / DN	INCHES / DN	cil./ cyl.	P1 bar / psi	P2 bar / psi	P3 bar / psi
10-15-20-25	1/2" - 3/4" - 1"	59	10/145	10/145	10/145
32-40	1 1/2"	83	10/145	10/145	10/145
50	2"	108	10/145	10/145	10/145
65	2 1/2"	108	10/145	10/145	10/145
80	3"	134	10/145	10/145	10/145
100	4"	134	9/130	9/130	9/130
125		207	-	-	-
150	6"	207	-	-	-

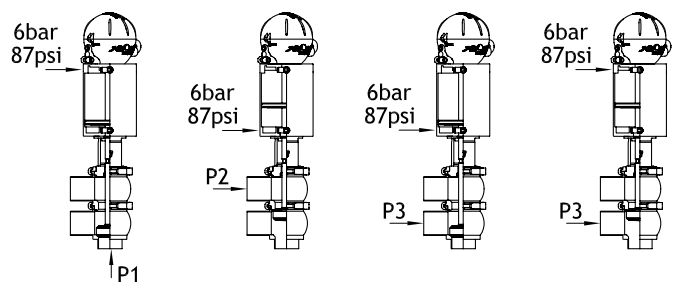

BBYP			
DN	S	S1	S2
40 - 1" 1/2	19	16.5	9.5
50 - 2"	33	31	14
65 - 2" 1/2	33	31	23
80 - 3"	33	31	30
100 - 4"	34	31	30

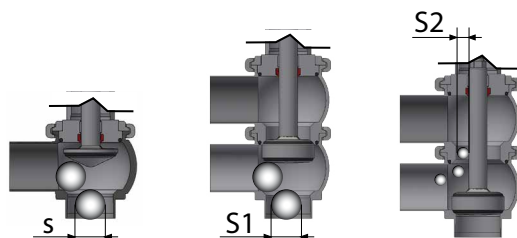

Consumi Aria - Air consumption				
Litri per pressione aria/ciclo - Litre for air pressure/cycle				
DIN / DN	INCHES / DN	ciL./ cyl.	SE NC	DE
10 - 15 - 20 - 25	1/2" - 3/4" - 1"	59	0.05	0.18
32 - 40	1" 1/2	83	0.19	0.56
50	2"	108	0.19	0.56
65	2" 1/2	108	0.48	1.43
80	3"	134	0.48	1.43
100	4"	134	0.71	2.76
125		207	0.71	2.76
150	6"	207	0.98	4.02

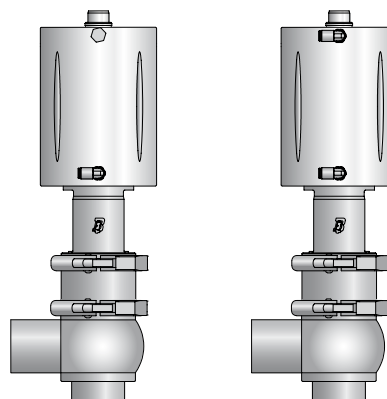

BBZT



BBZT
Deviatrice / Divert



CERTIFICAZIONI
CERTIFICATIONS



DATI TECNICI

STRUTTURA VALVOLA		
Connessioni da DN40 a DN150	DIN, SMS, IDF, BS (RJT), Clamp, Flangia	Altre connessioni a richiesta
Materiale a contatto con il prodotto	AISI 316L (1.4404)	Altro materiale a richiesta
Materiale guarnizioni a contatto con il prodotto (omologazione FDA)	EPDM, FKM, HNBR e PTFE	Altro materiale a richiesta
Temperatura massima prodotto (EPDM)	150 °C (302 °F)	Per temperature diverse, contattare Bardiani Valvole
Temperatura minima prodotto (EPDM)	-10 °C (14 °F)	
Pressione massima prodotto	10 bar (145 psi)	
Pressione massima di tenuta	Vedi tabella	
Finitura superficiale materiale a contatto con il prodotto	Ra 0,8 µm (altri tipi di finitura a richiesta)	
STRUTTURA ATTUATORE PNEUMATICO		
Attacchi aria	1/8" (BSP) per tubo 6 x 4 mm	
Pressione	Da 6 bar (87 psi) a 8 bar (116 psi)	
Materiale cilindro	AISI 304 (1.4301)	
Materiale guarnizioni	NBR	

TECHNICAL DETAILS

VALVE STRUCTURE		
Connections from DN40 to DN150	DIN, SMS, IDF, BS (RJT), Clamp, Flange	Other connections on request
Material in contact with the product	AISI 316L (1.4404)	Other material on request
Material gaskets in contact with the product (FDA homologation)	EPDM, FKM, HNBR and PTFE	Other material on request
Max. product temperature (EPDM)	150 °C (302 °F)	For other temperature, please ask Bardiani Valvole
Min. product temperature (EPDM)	-10 °C (14 °F)	
Max. product pressure	10 bar (145 psi)	
Max. working pressure	See table	
Finish on surfaces in contact with the product	Ra 0.8 µm (other types of surface finish on request)	
PNEUMATIC ACTUATOR STRUCTURE		
Air connectors	1/8" (BSP) for pipe 6 x 4 mm	
Air pressure	From 6 bar (87 psi) to 8 bar (116 psi)	
Cylinder material	AISI 304 (1.4301)	
Gasket material	NBR	

CILINDRO MAGGIORATO

La versatilità della valvole a singola sede permette di adattare i vari cilindri pneumatici in funzione delle pressioni di lavoro.

Per maggiori informazioni sulle pressioni di tenuta, contattare la Bardiani Valvole

OVERSIZED ACTUATOR

It is very easy to switch over-sized actuators for different working pressure. For further information please contact Bardiani Valvole.



BBYT

BARRIERA VAPORE

Impiegata in applicazioni particolarmente delicate dove sterilità, asetticità o alte temperature di sterilizzazione sono necessarie. L'utilizzo di una barriera di vapore posta tra il corpo valvola e la parte pneumatica consente di ottenere una sicura separazione fra prodotto all'interno della valvola ed ambiente esterno.

BBYT

STEAM BARRIER

A steam barrier is recommended for very hygiene applications such as sterile, aseptic processing or high temperature sterilization. The steam barrier, placed between the valve body and the pneumatic actuator, minimises the risk of the product coming into contact with the external atmosphere.

ESECUZIONI SPECIALI SU RICHIESTA

Ogni accessorio è disponibile su richiesta del cliente per tutti i diametri e tutte le configurazioni corpi valvola. È inoltre possibile la personalizzazione di attacchi, diametri oppure soluzioni non presenti a catalogo. Bardiani Valvole consiglia di consultare sempre l'ufficio tecnico in fase d'ordine per ulteriori informazioni e studi di fattibilità.

SPECIAL OPTIONS AND VARIATION ON REQUEST

On request all accessories are available for all sizes of valve and body configurations. Additionally special ports, diameters and other tailor-made solutions are available. Bardiani Valvole can also provide technical support, advice and feasibility analysis for other requests.

VALVOLA PNEUMATICA SINGOLA SEDE BBZT TWIN STOP PNEUMATIC SINGLE SEAT BBZT TWIN STOP

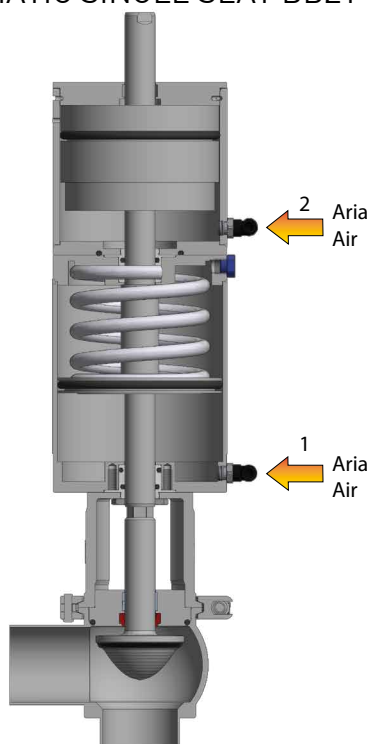

fig. 1

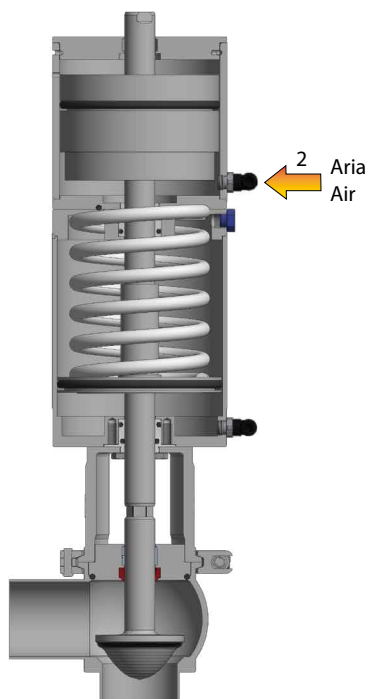

fig. 2



fig. 3

FUNZIONAMENTO

Per ottenere l'apertura della valvola, alimentare entrambi i cilindri con ingresso aria 1 e 2 (fig. 1). Togliendo aria dal cilindro inferiore si ottiene la chiusura parziale della valvola (fig. 2), questo movimento può essere registrato tramite l'apposito dispositivo di regolazione. Per effettuare la chiusura totale della valvola è sufficiente togliere aria dal cilindro superiore (fig. 3). È anche possibile ottenere un'apertura parziale della valvola alimentando solo il cilindro superiore tramite l'ingresso aria 2.

WORKING PRINCIPLE

To open the valve, supply air to both connections 1 + 2 (fig. 1). For partial closing release the air on the connection 1, while maintaining pressure on air connection 2 (fig. 2) the valve will partially close, this stroke can be adjusted and fixed, by a mechanical device equipped on the top of the valve. To close completely release the air from inlet 2 (fig. 3), both cylinders will now be free of air, and the spring returns the shutter in lower position. For partial opening, supply air to inlet 2 only.

BBWT1

VALVOLA CON MEMBRANA

La valvola è progettata per applicazioni sterili dove si richiede la massima sicurezza nell'intercettazione e/o nella deviazione del prodotto. La valvola è dotata di una nuova membrana in Gylon che garantisce una massima prestazione dell'impianto e una migliore efficienza della valvola.













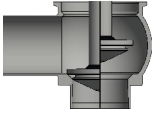

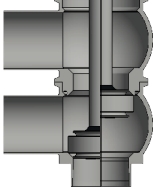

BBWT1

VALVE WITH MEMBRANE

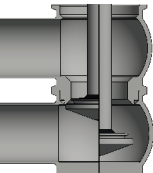
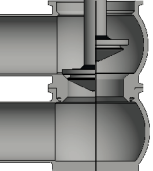
The valve has been designed for sterile applications which require safety in cutting off and/or directing of product. The valve features a New membrane in Gylon which ensures maximum operating performance and improved valve efficiency.

CONFIGURAZIONI **CORPI** VALVOLE ON-OFF VALVES **BODY** CONFIGURATIONS

1 L 	2 T 	V45° 		
↑	↑	←		Chiusa Aperta Closed Open
3 LL 	4 TL 	5 LT 	6 TT 	
P7-LL 	P7-TL 	P7-LT 	P7-TT 	
↙ ↘				
M8-LL 	M8-TL 	M8-LT 	M8-TT 	Chiusa Aperta Closed Open
↙ ↘				

↑ Direzione fluido raccomandata
 Recommended flow direction
 ↓ Recommended flow direction

ESEMPI DI LETTURA PER ATTACCHI MISTI EXAMPLES OF HOW TO READ END CONNECTIONS

1° - 2° - 3°... esempi di lettura per attacchi con tipi e/o dimensioni diverse
 1st - 2nd - 3rd examples of how to read end connections with different types and/or dimensions

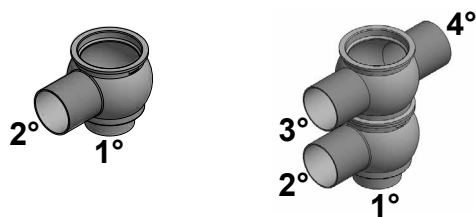

ESEMPI DI CONFIGURAZIONI ATTACCHI MISTI EXAMPLES OF DIFFERENT END CONNECTION CONFIGURATIONS

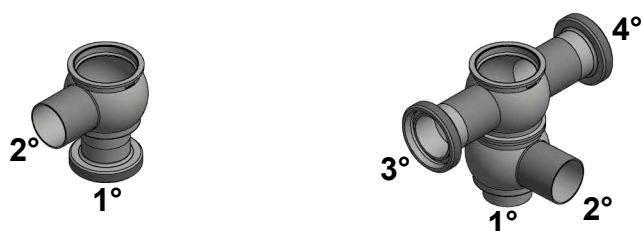

1L Femmina / Saldare
 1L Male / Weld

5LT Saldare / Femmina / Femmina
 5LT Weld / Male / Male

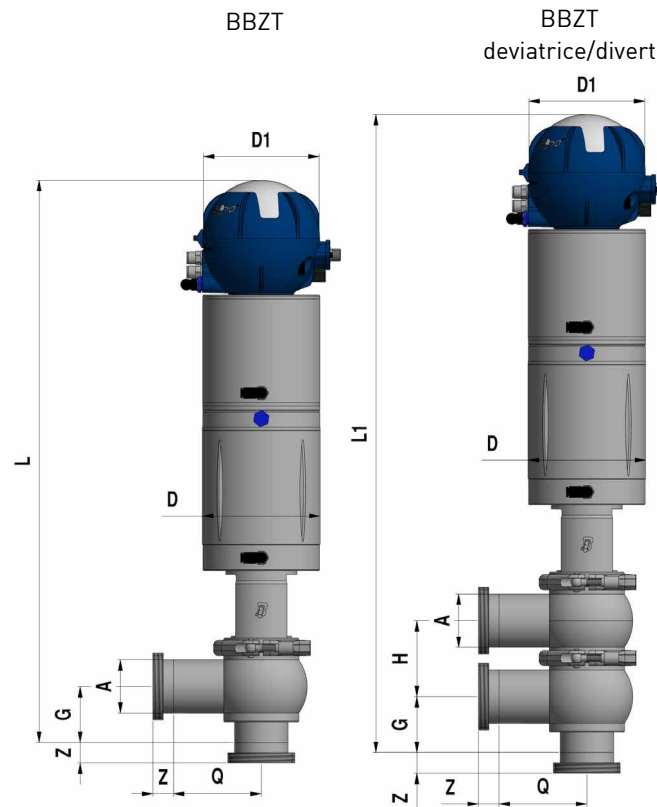

DN	S/S DIN 11850-2								F/F DIN	M/G DIN	S/S (altre dimensioni / other dimension)
	A	D	D1	G	H	L	L1	Q	Z	Z	A
40	41x1.5	90	112	49	62	457	519	70	33	26	40x1.5
50	53x1.5	115	112	55	74	545	619	85	35	28	52x1.5
65	70x2	115	112	63	90	561	651	95	40	32	70x2
80	85x2	140	145	70.5	105	625	730	105	45	37	85x2
100	104x2	140	145	80	124	644	768	120	54	44	104x2

DN	S/S INCHES								F/F SMS	F/F IDF	F/F BS
	A	D	D1	G	H	L	L1	Q	Z	Z	Z
1" 1/2	38.1x1.5	90	112	47.5	62	457	519	70	20	21.5	26.5
2"	50.8x1.5	115	112	54	74	545	619	85	20	21.5	26.5
2" 1/2	63.5x1.5	115	112	60.5	90	561	651	95	24	21.5	26.5
3"	76.1x2	140	145	66	105	625	730	105	24	21.5	26.5
4"	101.6x2	140	145	79	124	644	768	120	25	21.5	26.5

DN	S/S ASME-BPE								CLAMP
	A	D	D1	G	H	L	L1	Q	Z
1" 1/2	38.1x1.65	90	112	47.5	62	457	519	70	12.7
2"	50.8x1.65	115	112	54	74	545	619	85	12.7
2" 1/2	63.5x1.65	115	112	60	90	561	651	95	12.7
3"	76.2x1.65	140	145	66.5	105	625	730	105	12.7
4"	101.6x2.11	140	145	79	124	644	768	120	15.8

Altre dimensioni su richiesta / Other dimensions on request

LEGENDA / KEY	
S/S DIN	Saldare / Welding
F/F DIN	Femmina / Male
M/G DIN	Maschio + girella / Liner + nut
S/S DIN 11850/2	Saldare / Welding Din 11850/2
CLAMP	Clamp
F/F SMS	Femmina / Male SMS
F/F IDF	Femmina / Male IDF
F/F BS	Femmina / Male BS

S.E. N.C. / S.A. N.C.				
DIN / DN	INCHES / DN	cil./ cyl.	P1 bar / psi	P2 bar / psi
40	1" 1/2	83	9/130	10/145
50	2"	108	9/130	10/145
65	2" 1/2	108	5/72	6/87
80	3"	134	6/87	6/87
100	4"	134	4/58	4.5/65

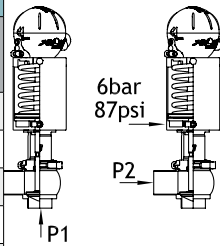

LEGENDA / KEY	
S.E.N.C. / S.A.N.C.	Valvola normalmente chiusa con attuatore a semplice effetto (molla chiude/aria apre) Valve normally closed with single acting actuator (air opens/spring closes)
S.E.N.A. / S.A.N.O.	Valvola normalmente aperta con attuatore a semplice effetto (aria chiude/molla apre) Valve normally opened with single acting actuator (air closes/spring opens)
D.E. / D.A.	Valvola con attuatore a doppio effetto (aria apre/aria chiude) Valve with double acting actuator (air opens/air closes)
cil/cyl	Cilindro / Cylinder
-	Su richiesta / On demand

S.E. N.C. / S.A. N.C.					
DIN / DN	INCHES / DN	cil./ cyl.	P1 bar / psi	P2 bar / psi	P3 bar / psi
40	1" 1/2	83	9/130	10/145	10/145
50	2"	108	9/130	10/145	10/145
65	2" 1/2	108	5/72	4.7/68	6.5/94
80	3"	134	6/87	4.7/68	6.5/94
100	4"	134	4/58	3.3/48	4.7/68

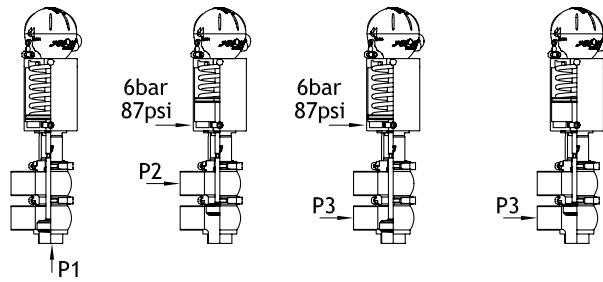

BBZT			
DN	S	S1	S2
40 - 1" 1/2	19	16.5	9.5
50 - 2"	33	31	14
65 - 2" 1/2	33	31	23
80 - 3"	33	31	30
100 - 4"	34	31	30

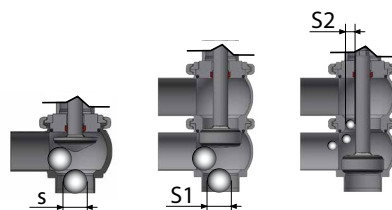

BBZO



DATI TECNICI

STRUTTURA VALVOLA		
Conessioni da DN25 a DN150	DIN, SMS, IDF, BS (RJT), Clamp, Flangia	Altre connessioni a richiesta
Materiale a contatto con il prodotto	AISI 316L (1.4404)	Altro materiale a richiesta
Materiale guarnizioni a contatto con il prodotto (omologazione FDA)	EPDM, FKM, HNBR e PTFE	Altro materiale a richiesta
Temperatura massima prodotto (EPDM)	150 °C (302 °F)	Per temperature diverse, contattare Bardiani Valvole
Temperatura minima prodotto (EPDM)	-10 °C (14 °F)	
Pressione massima prodotto	10 bar (145 psi)	
Pressione massima di tenuta	Vedi tabella	
Finitura superficiale materiale a contatto con il prodotto	Ra 0,8 µm (altri tipi di finitura a richiesta)	
STRUTTURA ATTUATORE PNEUMATICO		
Attacchi aria	1/8" (BSP) per tubo 6 x 4 mm	
Pressione	Da 6 bar (87 psi) a 8 bar (116 psi)	
Materiale cilindro	AISI 304 (1.4301)	
Materiale guarnizioni	NBR	

BBZOG

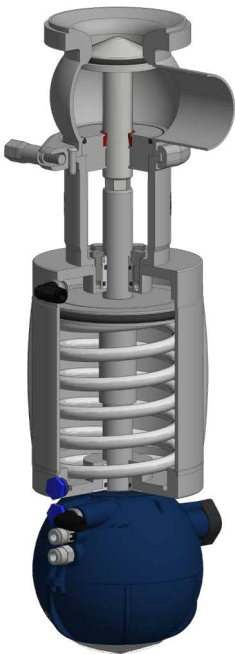

TECHNICAL DETAILS

VALVE STRUCTURE		
Connections from DN25 to DN150	DIN, SMS, IDF, BS (RJT), Clamp, Flange	Other connections on request
Material in contact with the product	AISI 316L (1.4404)	Other material on request
Material gaskets in contact with the product (FDA homologation)	EPDM, FKM, HNBR and PTFE	Other material on request
Max. product temperature (EPDM)	150 °C (302 °F)	For other temperature, please ask Bardiani Valvole
Min. product temperature (EPDM)	-10 °C (14 °F)	
Max product pressure	10 bar (145 psi)	
Max working pressure	See table	
Finish on surfaces in contact with the product	Ra 0.8 µm (other types of surface finish on request)	
PNEUMATIC ACTUATOR STRUCTURE		
Air connectors	1/8" (BSP) for pipe 6 x 4 mm	
Air pressure	From 6 bar (87 psi) to 8 bar (116 psi)	
Cylinder material	AISI 304 (1.4301)	
Gasket material	NBR	

CERTIFICAZIONI
CERTIFICATIONS



BBZMF-BBZMG

VALVOLA AD AZIONAMENTO
MANUALE CON/SENZA LEVA



BBZMF-BBZMG

MANUAL OPERATED VALVE
WITH/WITHOUT HANDLE

BBYO-BBYOG

BARRIERA VAPORE

Impiegata in applicazioni particolarmente delicate dove sterilità, asetticità o alte temperature di sterilizzazione sono necessarie. L'utilizzo di una barriera di vapore posta tra il corpo valvola e la parte pneumatica consente di ottenere una sicura separazione fra prodotto all'interno della valvola ed ambiente esterno.

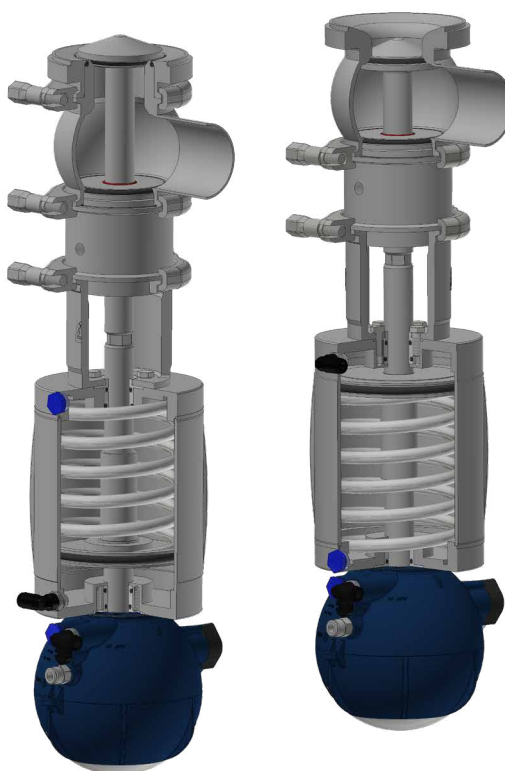

BBYO-BBYOG

STEAM BARRIER

A steam barrier is recommended for very hygiene applications such as sterile, aseptic processing or high temperature sterilization. The steam barrier, placed between the valve body and the pneumatic actuator, allows a safe separation between product inside the valve and external environment.

CILINDRO MAGGIORATO

La versatilità della valvole a singola sede permette di adattare i vari cilindri pneumatici in funzione delle pressioni di lavoro. Per maggiori informazioni sulle pressioni di tenuta, contattare la Bardiani Valvole



OVERSIZED ACTUATOR

It is very easy to switch over-sized actuators for different working pressure. For further information please contact Bardiani Valvole.

BBW01-BBW0G1

VALVOLA CON MEMBRANA

La valvola è progettata per applicazioni sterili dove si richiede la massima sicurezza nell'intercettazione e/o nella deviazione del prodotto. La valvola è dotata di una nuova membrana in Gylon che garantisce una massima prestazione dell'impianto e una migliore efficienza della valvola.



BBW01-BBW0G1

MEMBRANE

The valve has been designed for sterile applications which require safety in cutting off and/or directing of product. The valve features a New membrane in Gylon which ensures maximum operating performance and improved valve efficiency,

ESECUZIONI SPECIALI SU RICHIESTA

Ogni accessorio è disponibile su richiesta del cliente per tutti i diametri e tutte le configurazioni corpi valvola. E' inoltre possibile la personalizzazione di attacchi, diametri oppure soluzioni non presenti a catalogo. Bardiani Valvole consiglia di consultare sempre l'ufficio tecnico in fase d'ordine per ulteriori informazioni e studi di fattibilità.

SPECIAL OPTIONS AND VARIATION ON REQUEST

On request all accessories are available for all sizes of valve and body configurations. Additionally special ports, diameters and other tailor-made solutions are available. Bardiani Valvole can also provide technical support, advice and feasibility analysis for other requests.

CONFIGURAZIONI CORPI VALVOLA ON-OFF VALVE CONFIGURATIONS

BBZOG

Configurazioni corpi valvola con flangia su 1° attacco
Valve bodies configurations with 1st port flanged

1 L

2 T

V45°

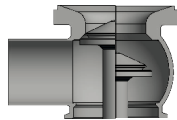

Chiusa Aperta
Closed Open

BBZOG

Configurazioni corpi valvola senza flangia su 1° attacco
Valve bodies configurations without 1st port flanged

1 L

2 T



BBZO

1 L

2 T

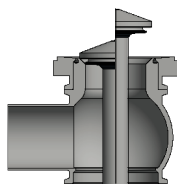

Chiusa Aperta
Closed Open

ESEMPI DI LETTURA PER ATTACCHI MISTI EXAMPLES OF HOW TO READ END CONNECTIONS

1°- 2°- 3°.... esempi di lettura per attacchi con tipi e/o dimensioni diverse

1st - 2nd - 3rd examples of how to read end connections with different types and/or dimensions



ESEMPI DI CONFIGURAZIONI ATTACCHI MISTI EXAMPLES OF DIFFERENT END CONNECTION CONFIGURATIONS



2T Flangia / Saldare / Clamp

2T Flange / Weld / Clamp

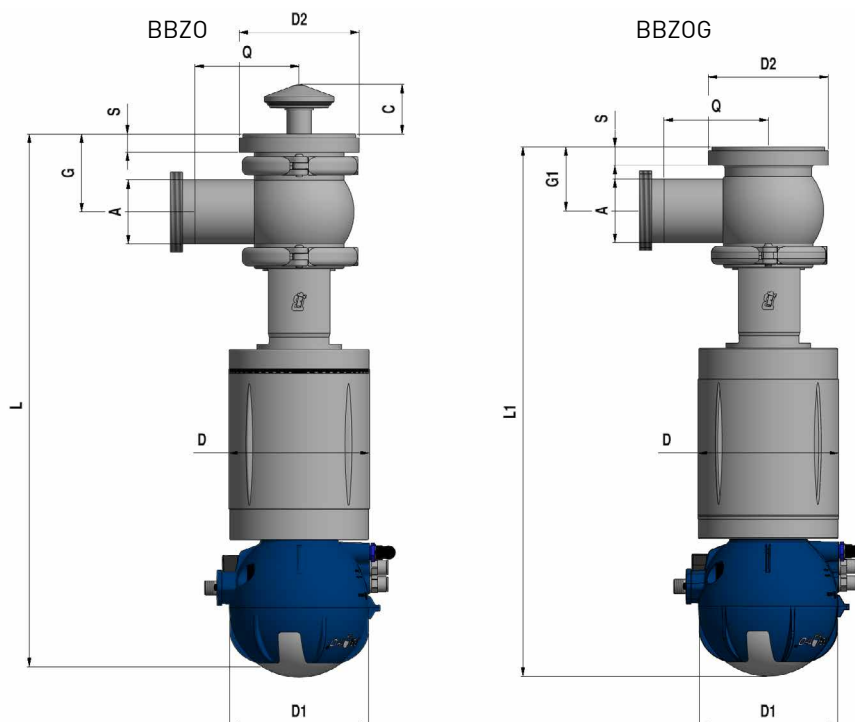

DN	S/S DIN 11850-2										F/F DIN	M/G DIN	S/S (altre dimensioni / other dimension)	
	A	C	D	D1	D2	G	G1	L	L1	Q				S
25	29x1.5	25	90	90	84	63	51	378	365	70	15	29	22	28x1.5
32	35x1.5	25	90	90	84	60	48	378	365	70	15	32	25	34x1.5
40	41x1.5	25	90	112	84	58	45	381	366	70	15	33	26	40x1.5
50	53x1.5	36	115	112	98	64	52	440	429	85	15	35	28	52x1.5
65	70x2	40	115	112	124	71	60	458	445	95	15	40	32	
80	85x2	40	140	145	144	79	68	520	509	105	15	45	37	
100	104x2	40	140	145	169	89	78	539	528	120	15	54	44	
125	129X2	73.5	219	145	234	121	94.5	699	670	140	20	46	34	
150	154X2	70	219	145	248	133.5	110	723	700	155	20	50	37	

DN	S/S INCHES										F/F SMS	F/F IDF	F/F BS	
	A	C	D	D1	D2	G	G1	L	L1	Q				S
1"	25.4x1.5	25	90	90	84	64	51	378	364	70	15	15	21.5	26.5
1" 1/2	38.1x1.5	25	90	112	84	58	46	378	365	70	15	20	21.5	26.5
2"	50.8x1.5	36	115	112	98	64	53	440	429	85	15	20	21.5	26.5
2" 1/2	63.5x1.5	40	115	112	124	75	63	458	445	95	15	24	21.5	26.5
3"	76.1x2	40	140	145	144	83	72	520	509	105	15	24	21.5	26.5
4"	101.6x2	40	140	145	169	89	78	539	528	120	15	25	21.5	26.5

DN	S/S ASME-BPE											CLAMP
	A	C	D	D1	D2	G	G1	L	L1	Q	S	
1"	25.4x1.65	25	90	90	84	64	51	378	364	70	15	12.7
1" 1/2	38.1x1.65	25	90	90	84	58	46	378	365	70	15	12.7
2"	50.8x1.65	36	115	112	98	64	53	440	429	85	15	12.7
2" 1/2	63.5x1.5	40	115	112	124	75	63	458	445	95	15	12.7
3"	76.2x1.65	40	140	145	144	83	72	520	509	105	15	12.7
4"	101.6x2.11	40	140	145	169	89	78	539	528	120	15	15.8
6"	152.4X2.77	70	219	145	248	137.5	110.5	785.5	698	155	20	28.6

LEGENDA / KEY	
S/S DIN	Saldare / Welding
F/F DIN	Femmina / Male
M/G DIN	Maschio + girella / Liner + nut
S/S DIN 11850/2	Saldare / Welding Din 11850/2
CLAMP	Clamp
F/F SMS	Femmina / Male SMS
F/F IDF	Femmina / Male IDF
F/F BS	Femmina / Male BS

Altre dimensioni su richiesta / Other dimensions on request

BBZO

S.E.N.C. / S.A.N.C.				
DIN / DN	INCHES / DN	ciL. / cyl.	P1 bar / psi	P2 bar / psi
25	1"	83	7/101	10/145
32-40	1 1/2"	83	7/101	10/145
50	2"	108	7/101	10/145
65	2 1/2"	108	4/58	6/87
80	3"	134	4/58	6/87
100	4"	134	3/43	4.2/61

S.E.N.A. / S.A.N.O.				
DIN / DN	INCHES / DN	ciL. / cyl.	P1 bar / psi	P2 bar / psi
25	1"	83	7/101	10/145
32-40	1 1/2"	83	7/101	10/145
50	2"	108	7/101	10/145
65	2 1/2"	108	4/58	5/72
80	3"	134	4/58	5/72
100	4"	134	3/43	3.5/51

D.E. / D.A.				
DIN / DN	INCHES / DN	ciL. / cyl.	P1 bar / psi	P2 bar / psi
25	1"	83	10/145	10/145
40	1 1/2"	83	10/145	10/145
50	2"	108	10/145	10/145
65	2 1/2"	108	10/145	10/145
80	3"	134	10/145	10/145
100	4"	134	9/130	9/130

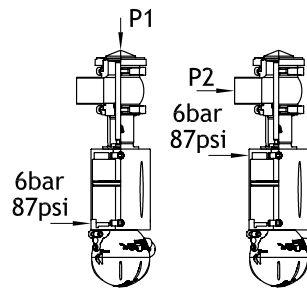
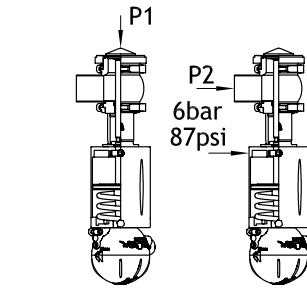
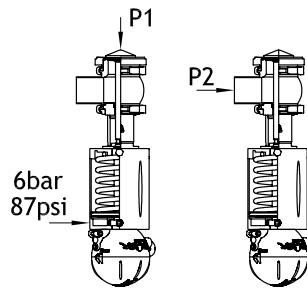

LEGENDA / KEY	
S.E.N.C. / S.A.N.C.	Valvola normalmente chiusa con attuatore a semplice effetto (molla chiude/aria apre) Valve normally closed with single acting actuator (air opens/spring closes)
S.E.N.A. / S.A.N.O.	Valvola normalmente aperta con attuatore a semplice effetto (aria chiude/molla apre) Valve normally opened with single acting actuator (air closes/spring opens)
D.E. / D.A.	Valvola con attuatore a doppio effetto (aria apre/aria chiude) Valve with double acting actuator (air opens/air closes)
ciL./cyl.	Cilindro / Cylinder
-	Su richiesta / On demand

BBZOG

S.E.N.C. / S.A.N.C.				
DIN / DN	INCHES / DN	ciL. / cyl.	P1 bar / psi	P2 bar / psi
25	1"	83	9/130	10/145
40	1 1/2"	83	9/130	10/145
50	2"	108	9/130	10/145
65	2 1/2"	108	5/72	6/87
80	3"	134	6/87	6/87
100	4"	134	4/58	4.5/65

S.E.N.A. / S.A.N.O.				
DIN / DN	INCHES / DN	ciL. / cyl.	P1 bar / psi	P2 bar / psi
25	1"	83	9/130	10/145
40	1 1/2"	83	9/130	10/145
50	2"	108	9/130	10/145
65	2 1/2"	108	4.5/65	6.5/94
80	3"	134	4.5/65	8/116
100	4"	134	3.2/46	5/72

D.E. / D.A.				
DIN / DN	INCHES / DN	ciL. / cyl.	P1 bar / psi	P2 bar / psi
25	1"	83	10/145	10/145
40	1 1/2"	83	10/145	10/145
50	2"	108	10/145	10/145
65	2 1/2"	108	10/145	10/145
80	3"	134	10/145	10/145
100	4"	134	9/130	9/130

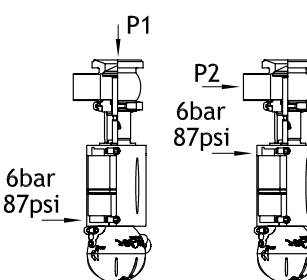
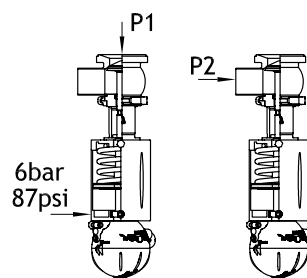
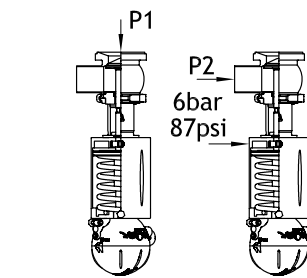

BBZOG	
DN	S
40 - 1" 1/2	19
50 - 2"	33
65 - 2" 1/2	33
80 - 3"	33
100 - 4"	34

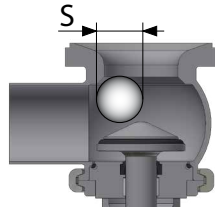

BBZO	
DN	S
40 - 1" 1/2	8
50 - 2"	13
65 - 2" 1/2	23
80 - 3"	22
100 - 4"	22

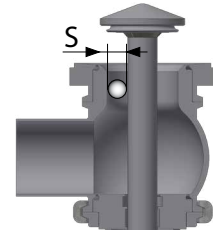

Consumi Aria - Air consumption				
Litri per pressione aria/ciclo - Litre for air pressure/cycle				
DIN / DN	INCHES / DN	ci./ cyl.	SE NC	DE
10-15-20-25	1/2" - 3/4" - 1"	83	0.05	0.18
32-40	1" 1/2	83	0.19	0.56
50	2"	108	0.19	0.56
65	2" 1/2	108	0.48	1.43
80	3"	134	0.48	1.43
100	4"	134	0.71	2.76

